

V = 28 m³, A: 9.070 mm, E: 3.040 mm, B: 7.470 mm, F: 1.500 mm

Wywrotka aluminiowa tylnozsypowa - kłapa wewnętrzna

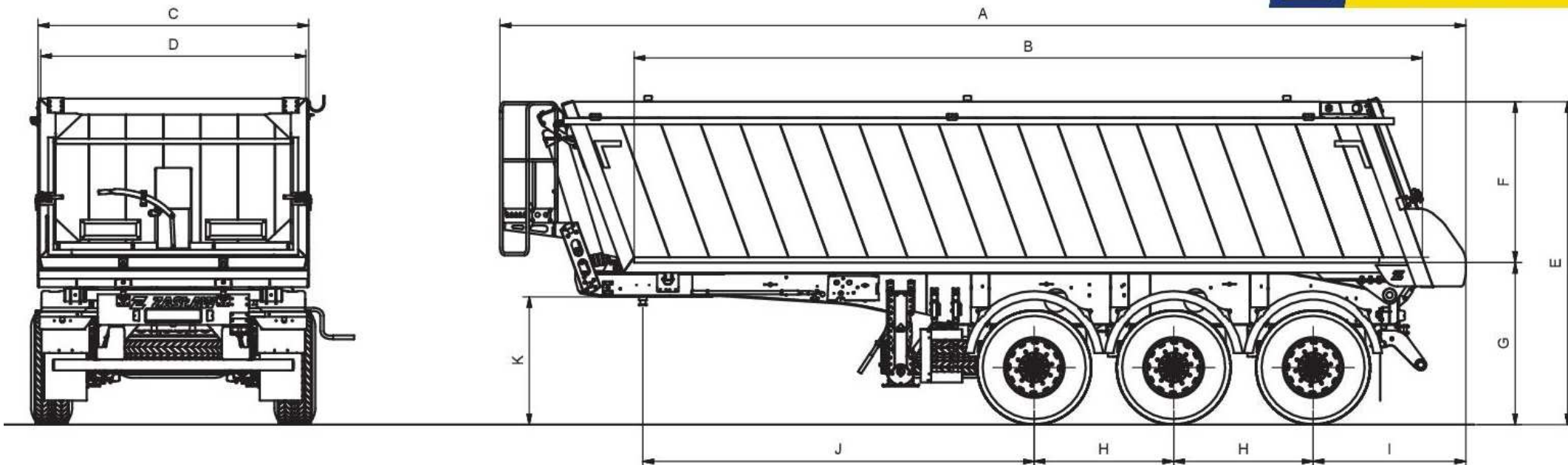

www.zaslaw-trails.pl / mail: info@zaslaw-trails.pl